

GREASE TRAP



MACTRAP 500L GREASE TRAP DATASHEET

Can be installed above or below ground.

Sales code	Total volume (litres)	Treatment capacity (litres)	Length (mm)	Width (mm)	Height (mm)	Inlet invert	Outlet invert
MTPT500 (S) (A) (D)	700	515	1500	550	850	670	625

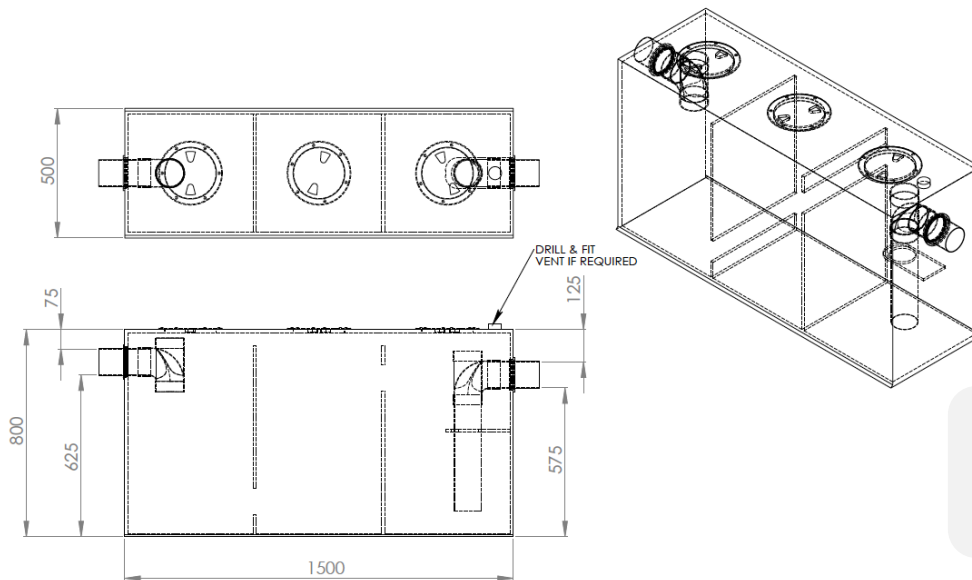

MTPT500S
ABOVE GROUND

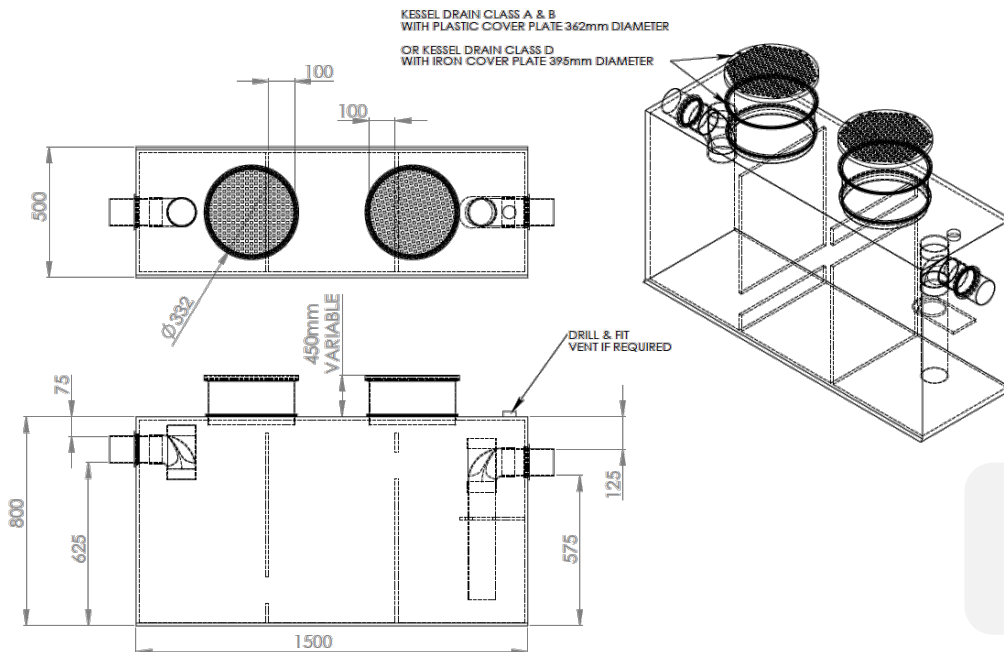

MTPT500A & MTPT500D
BELOW GROUND



COVERS AND RISERS

Mastrap grease traps can be installed in ground or above ground. The upper surface of the grease trap is not considered load bearing, so if the installation will carry load then risers and covers should be installed.

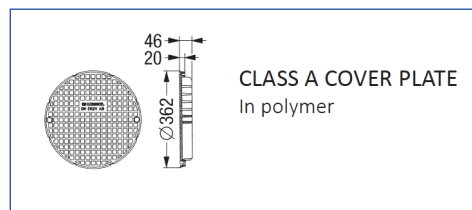
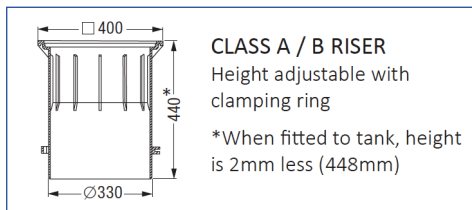
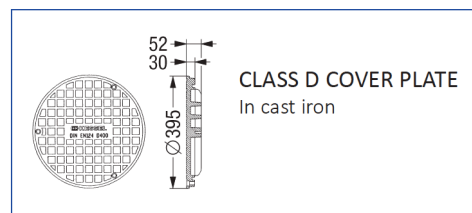
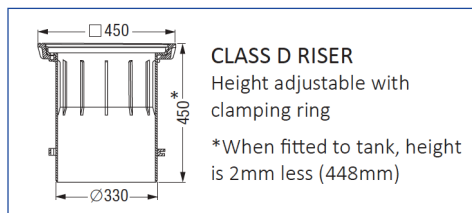

- Mastrap passive traps are available with HDPE trafficable lids in Class A (pedestrian) and Class D (vehicular).
- Flexible coupling allows easy installation into the surrounding medium.
- Fully sealed.
- Surrounding concrete or other medium must be engineered to the appropriate loading.



The risers are made from the same HDPE as the grease trap. The lids are sealed and are manufactured to Class A & D specifications. The riser(s) default length is 450mm but can be supplied at any length up to 2m.

The riser mounts are pre-welded and the riser flanges and screw on lids are provided separately. The riser flanges and screw on lids are installed once the exact height of the installation is known. The risers can be cut on site to the required height.

Refer to the installation details for pedestrian or vehicular traffic loading.

Type	Class	Typical Use	Nominal Wheel Loading (kg)	Serviceability Design Load (kN)	Ultimate Limit State Design (kN)
	A	Areas accessible strictly by pedestrians. Not suited to vehicles. Purpose – residential backyards, walkways not accessible by vehicles.	330kg	6.7kN	10kN
	D	Major roads including freeway and motorway shoulders. Warehouse and loading docks. Purpose – major roads.	8,000kg	160kN	240kN



ABOVE GROUND INSTALLATION

Location

Install the grease trap in a location that is accessible by manual or vacuum tanker so that it can be regularly cleaned out.

Locate the grease trap on a firm surface and brace it to a wall or alternative support to prevent it from moving or tipping.

Allow room above the grease trap for removal of the lids and access for the cleaning service. If possible, have clearance at least the maximum depth of the grease trap.

If the grease trap will be exposed to direct sunlight in temperatures that can exceed 30°C then consider a shade structure.

If the grease trap will be exposed to temperatures below 0°C then consider a frost cover.

Ensure that the sink pickup point is above the inlet height.

If necessary, the grease trap can be partially buried so that the inlet invert is at the most appropriate height to suit the inlet plumbing.

- a) Cut the hole as close as possible to the size of the grease trap.
- b) Ensure the base is flat and firm with even compaction and at least 25mm of sand.
- c) Back fill the sides with sand and lightly compact.
- d) Leave the lids exposed for access and service.

THE GREASE TRAP IS NOT LOAD BEARING

Installing on wall or under floor (hanging)

Ensure full base of the grease trap is supported and at least one horizontal mid-point support is installed laterally around the grease trap to mitigate any risk of bulge due to excessive heat or movement.

Ensure that the support medium is correctly engineered to hold the full laden weight of the grease trap.

Venting

The grease trap must be vented off either inlet or outlet, close to the tank, to ensure good ventilation.

The grease trap can be vented from the top surface if required. If installing a vent from the top surface of the grease trap, then install a 50 -100 mm vent (depending upon local authority requirement) using a bulkhead fitting or appropriate seal.

If cross ventilation is required, then install one vent at each end of the grease trap.

If the outlet is direct to sewer, then local authority regulations may mandate a vent on the outlet.

Backflow prevention

If backflow prevention is a local authority requirement, then the backflow prevention device should be installed within five metres of the grease trap.

Connections

The invert level of inlet and outlet are set. Do not raise or lower the inlet or outlet. If the invert of the outlet is too high the inlet connection may be submerged. The invert of the outlet pipe must remain lower than the invert of the inlet pipe.

The outlet pipe must never be of lesser diameter than the inlet pipe.

The grease trap is not to be used as a relief overflow point. Install a gully in addition to the grease trap and a running trap if part of a stacked line.



BELOW GROUND INSTALLATION

With Class A Pedestrian or Class D Vehicular Risers and Covers

Location

Install the grease trap in a location that is accessible by manual or vacuum tanker so that it can be regularly cleaned out.

The Class A and Class D lids are in the form of a variable height riser that the cover fits over and is settled into a load bearing pedestrian or traffic strata. These are to be inserted into concrete or surround.

NO LOADING IS TO BE APPLIED TO THE GREASE TRAP

An engineer's detail is required to ensure the risers and cover plates are set and located on a substrate that will hold the appropriate class cover. This means a concrete surround or steel frame to engineer's requirement installed above the grease trap to take traffic weight.

Installation Example

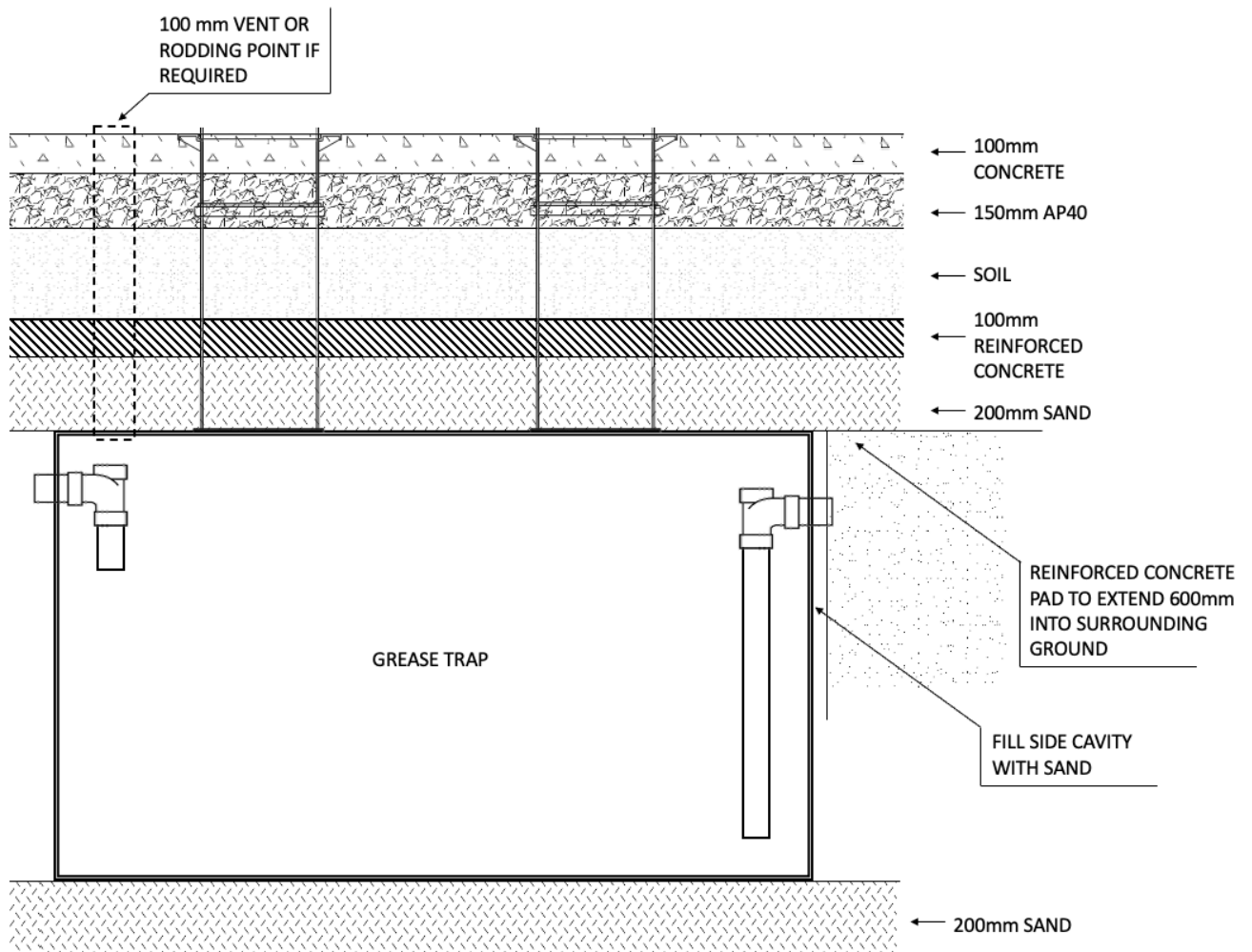

Load Bridge

Ensure that the load bridge extends at least 600mm onto the surrounding stable ground.

The Class D vehicular load bridge must be constructed using reinforced concrete. An engineer's detail is required for the load bridge specification for heavy vehicles.

Ground Water

If the grease trap is installed in areas with high water tables, or in areas subject to flooding, then the installation must include restraints or engineered load bridge that prevent the grease trap from floating out of the ground.

If 70% of the grease trap's storage capacity falls below the flood level, then anchor the grease trap.

Venting

The grease trap must be vented off either inlet or outlet, close to the tank, to ensure good ventilation.

The grease trap can be vented from the top surface if required. If installing a vent from the top surface of the grease trap, then install a 50 -100 mm vent (depending upon local authority requirement) using a bulkhead fitting or appropriate seal.

If the outlet is direct to sewer, then local authority regulations may mandate a vent on the outlet.

Backflow prevention

If backflow prevention is a local authority requirement, then the backflow prevention device should be installed within five metres of the grease trap.

Connections

The invert level of inlet and outlet are set. Do not raise or lower the inlet or outlet. If the invert of the outlet is too high the inlet connection may be submerged. The invert of the outlet pipe must remain lower than the invert of the inlet pipe.

The outlet pipe must never be of lesser diameter than the inlet pipe.

OPERATION

The Mactrap grease trap operates by allowing gravity to separate fats, oils, and grease (FOG) and sediments from discarded greasy water. A series of baffles slows the flow of water and reduces turbulence, allowing lighter than water FOG to float to the surface and heavier than water sediment to sink to the bottom. Cleaner wastewater flows from the grease trap while the FOG and sediment is retained within the grease trap.

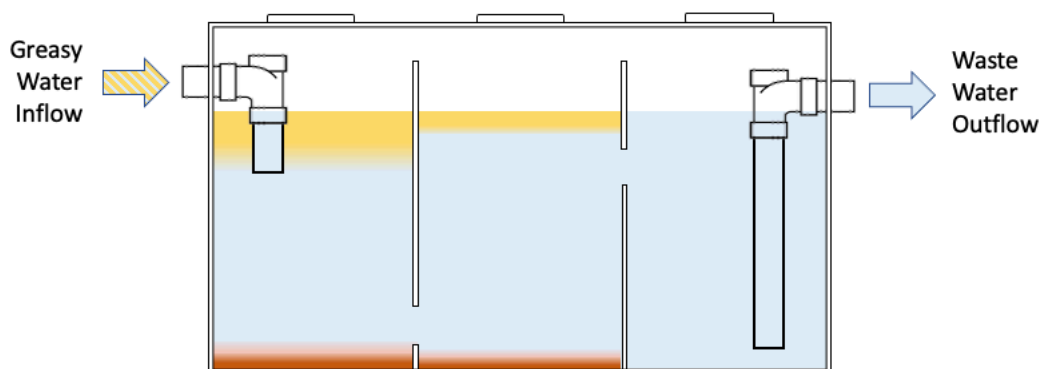

The very simple principle of operation works efficiently until the level of FOG increases to the point where separation fails and the wastewater outflow contains FOG, or the sediment levels increase to the point where the outflow is blocked. To ensure the continuing efficiency of the grease trap it must be periodically cleaned, and both the FOG and sediment removed.



AFTER-INSTALLATION CARE AND SERVICING

Whilst this product is highly robust, care is required to ensure efficient operation.

Water temperature

The grease trap is certified to operate with water temperatures up to 65°C. Higher continuous temperatures may cause sagging.

Chemicals

The grease trap is tested to handle most kitchen factory type chemicals especially as they are usually diluted with water. Pure benzene and concentrated sulphuric acid should not be used.

Sink Filters

Grease traps are not a rubbish bin, so the more solid rubbish pre-removed using sink filters, the higher the efficiency of the grease trap operation. FOG solidifying on the surface of the water is not the major source of distasteful odours. Food solids rotting as sediment is typically the source.

Clean Out

The frequency of clean out is totally dependent on how much fat, oil and grease is intercepted. Under normal usage, Mactrap recommends at least two clean outs per year, however heavy use or excess solids may require more frequent clean outs. In normal circumstances grease traps are cleaned out by a vacuum truck. The entire contents are drained and removed before refilling the grease trap for continued operation.

AVOID FOOD SOLIDS GETTING INTO THE GREASE TRAP

WARRANTY

Mactrap polymer grease traps are manufactured from high molecular weight HDPE with minimum 12mm wall thickness. They have slot filleted baffles and walls to ensure perfect welding and virtually no loss of strength to the HDPE.

The Mactrap polymer grease trap plastic is warranted for impermeability, fitness for use and structural stability for 30 years if installed underground and for 10 years if installed above ground. The manufactured unit is warranted for quality of manufacture for 5 years provided installation and operation are as per these specifications provided with each unit. Mactrap expressly states that wear and tear is not a defect and the same applies to defects from defective servicing.

The Mactrap polymer grease traps have flexible Wallace seals to ensure long life of the main inlet and outlet connections as well as flexibility with water tightness in ground movement.

